



vogue design stefano conficconi 2023

Modular sofa with a metal frame supported by elastic belts. Seat cushion and backrest padded with expanded polyurethane foam, covered with siliconized microfiber. Wooden armrest frame padded with expanded polyurethane foam covered with siliconized microfiber. The legs are in black chrome-plated metal or polished chrome-plated.

Divano modulare con fusto in metallo e supporto di nastri elastici. Cuscino di seduta e schienale imbottito con poliuretano espanso ricoperto in microfibra siliconata. Struttura bracciolo in legno imbottito con poliuretano espanso ricoperto con microfibra siliconata. Piedi disponibili in metallo cromato nero o cromato lucido.

seat height

altezza seduta
42 cm
16.5"

seat depth

profondità seduta
63 cm
24.8"

arm width

larghezza braccio
30 cm
11.8"

arm height

altezza braccio
51 cm
20.1"

feet height

altezza piede
19 cm
7.5"

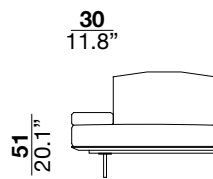
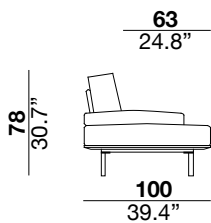

2

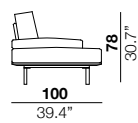
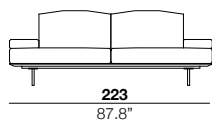

3

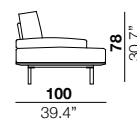
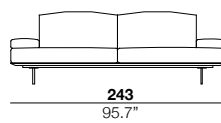

X

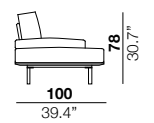
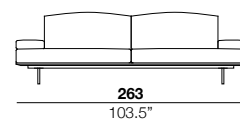

SX

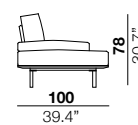
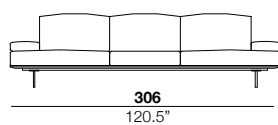

XG

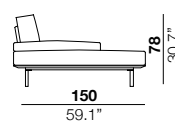
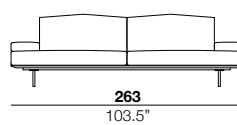

04

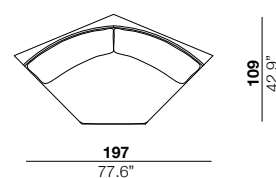

07/08

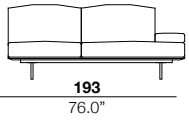
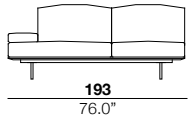

09/10

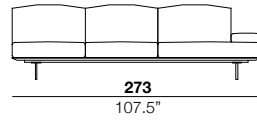
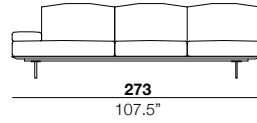

15G/16G

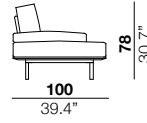
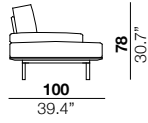
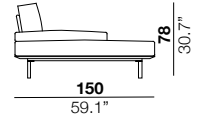
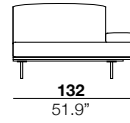
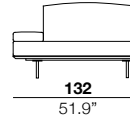

19/20

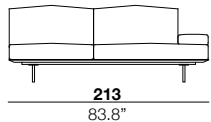
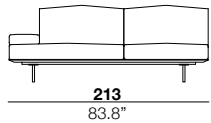

29/30

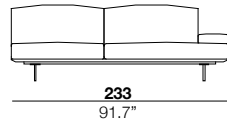
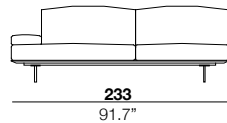

17/18

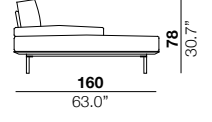
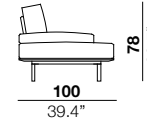
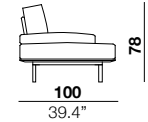
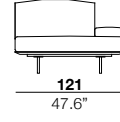
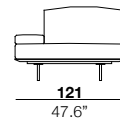

75/76

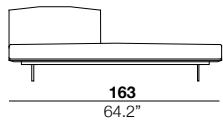
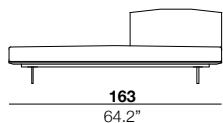

77/78

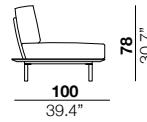
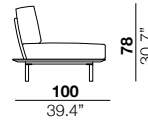
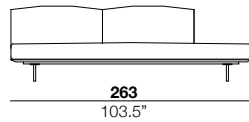
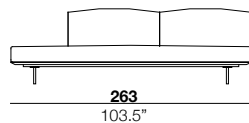

PAT

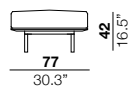
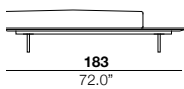

PRT

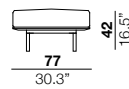
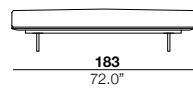

TQ

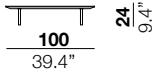
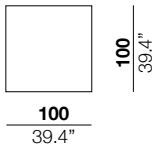

15G+16G

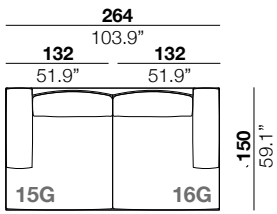

75+04+30

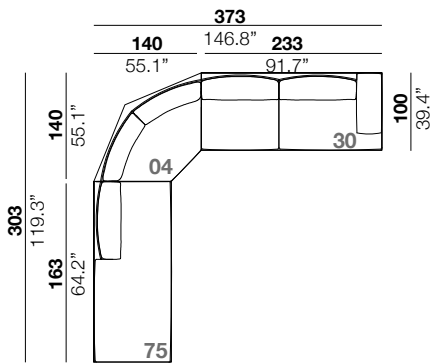

TR

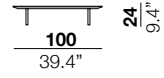
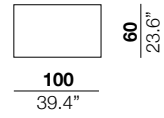

17+20

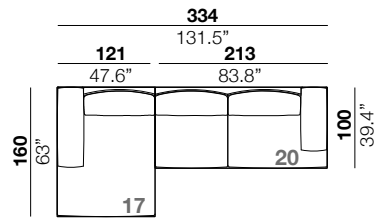

TT

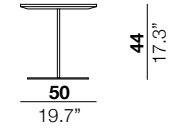
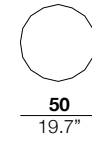

TR+78+TQ+30

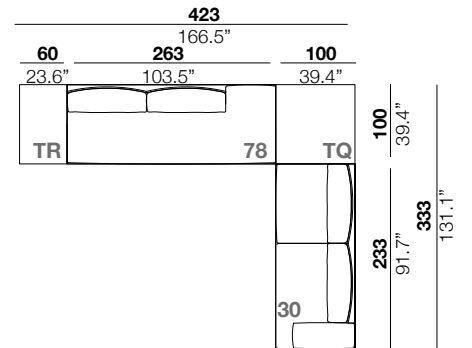



vogue cuoio design stefano conficconi 2023

Modular sofa with a metal frame supported by elastic belts. Seat cushion and backrest padded with expanded polyurethane foam, covered with siliconized microfiber. Wooden armrest frame padded with polyurethane foam covered with siliconized microfiber. Sofa basement and backrest frame with special finishing raw cut edges, can only be made in leather Setanil or Soffio. Coffee tables are finished with raw cut edges. The legs are in black chrome-plated metal or polished chrome-plated.

Divano modulare con fusto in metallo e supporto di nastri elastici. Cuscino di seduta e schienale imbottiti con poliuretano espanso ricoperto con microfibra siliconata. Struttura bracciolo in legno imbottito con poliuretano espanso ricoperto con microfibra siliconata. Base del divano e struttura schienali realizzati con una speciale lavorazione a taglio vivo disponibile solo nelle pelli Setanil e Soffio. Tavolini realizzati con lavorazione a taglio vivo. Piedi disponibili in metallo cromato nero o cromato lucido.

seat height

altezza seduta
42 cm
16.5"

seat depth

profondità seduta
63 cm
24.8"

arm width

larghezza braccio
30 cm
11.8"

arm height

altezza braccio
51 cm
20.1"

feet height

altezza piede
19 cm
7.5"

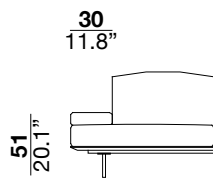
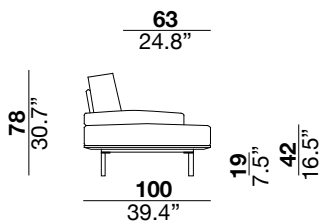

2

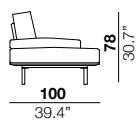
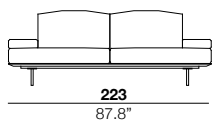

3

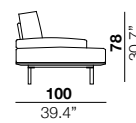
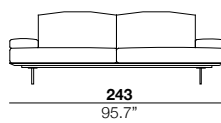

X

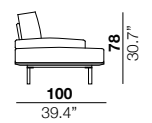
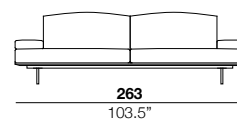

SX

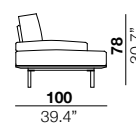
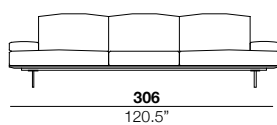

XG

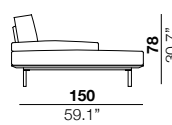
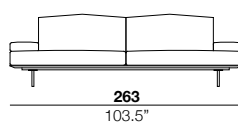

04

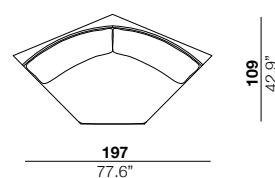

07/08

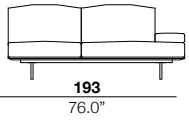
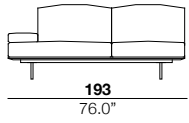

09/10

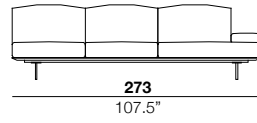
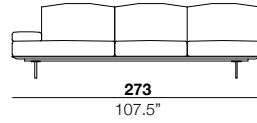

15G/16G

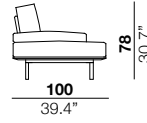
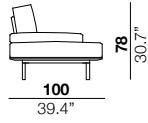
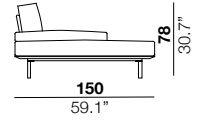
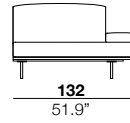
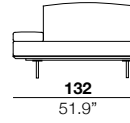

19/20

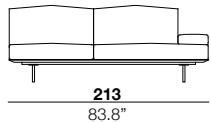
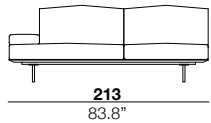

29/30

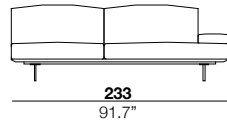
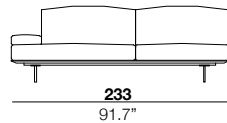

17/18

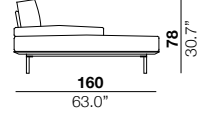
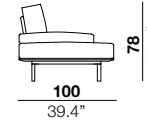
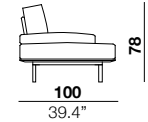
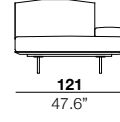
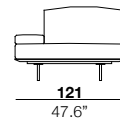

75/76

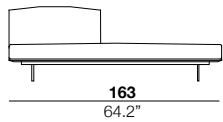
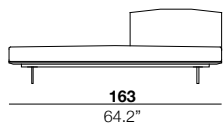

77/78

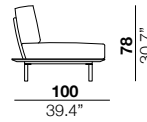
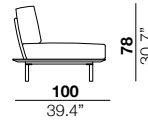
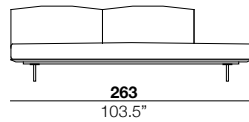
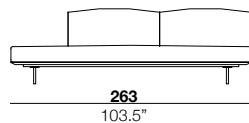

PAT

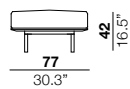
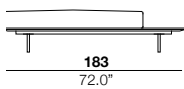

PRT

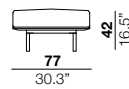
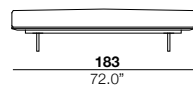

TQ

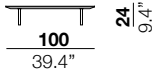
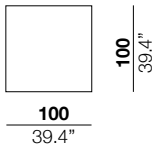

15G+16G

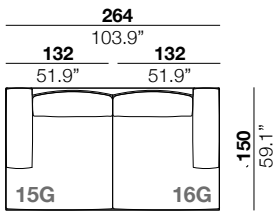

75+04+30

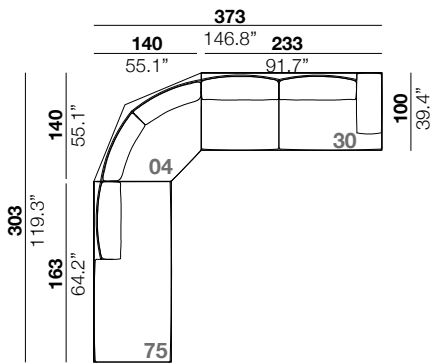

TR

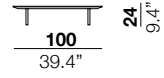
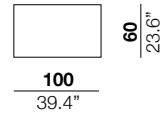

17+20

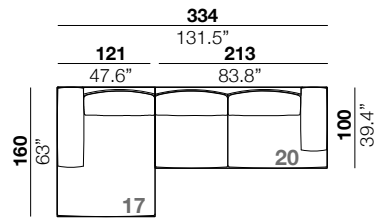

TT

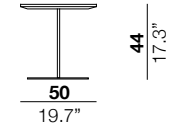
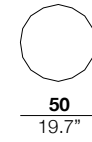

TR+78+TQ+30

